

CSA 130

Canale modulare in PVC
mm. 130x150x500

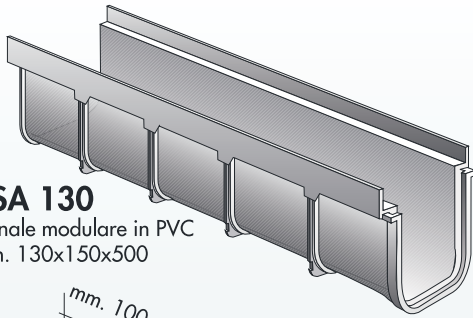

TCA 130

Testata unica
con scarico
Ø mm.100

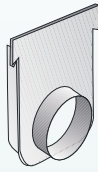

TCA 131

Testata unica
con scarico
Ø mm.110



CAGS 130

Giunto con scarico:
Laterali Ø mm. 75 F - mm. 80 M
Inferiore Ø mm. 75 F - mm. 80 M

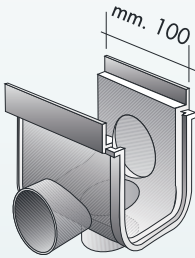

CAAND 130

Angolo destro alto

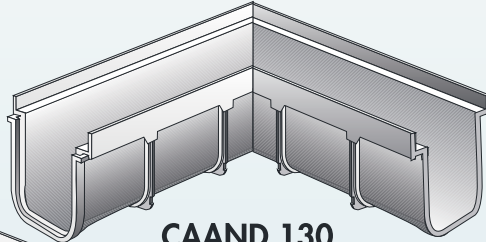

CAANS 130

Angolo sinistro alto

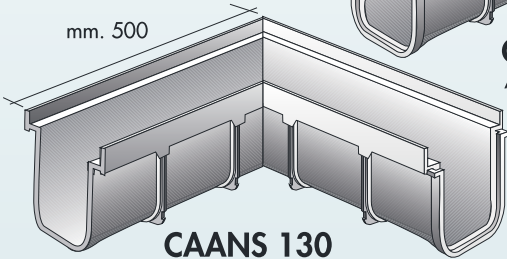

MULTIGRIL
BREVETTATO

MG 13999

Griglia in PA66FV
mm. 130x1000

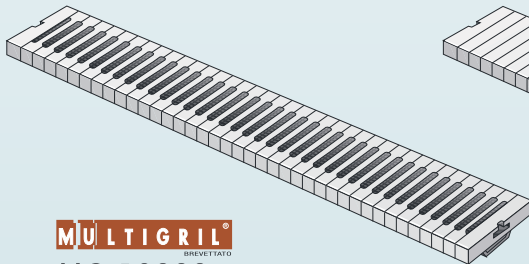

MULTIGRIL
BREVETTATO

MC 13999

Coperchio in PA66FV
mm. 130x1000

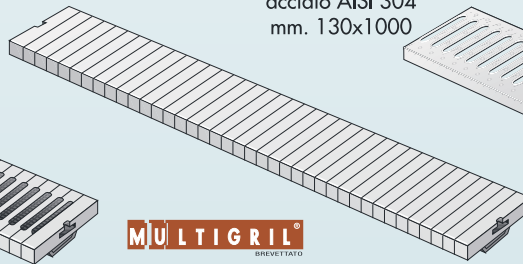

GS 13999

Griglia stampata in
acciaio AISI 304
mm. 130x1000

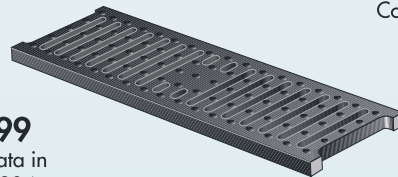

GRP 130

Griglia a norma
per piscine
mm. 130x500

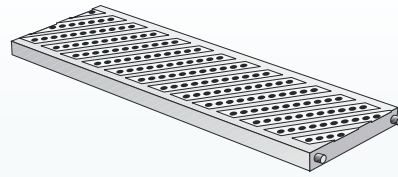

SGR 130

Griglia carrabile
mm. 130x500

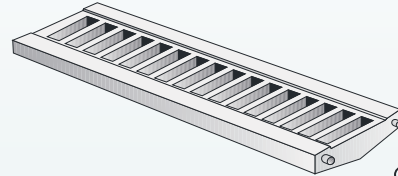

CGRN 130

Griglia carrabile
mm. 130x500

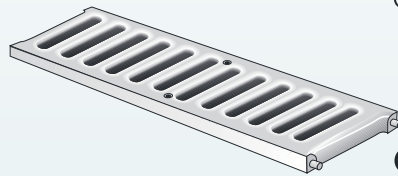

TCRP 130

Coperchio leggero
mm. 130x500

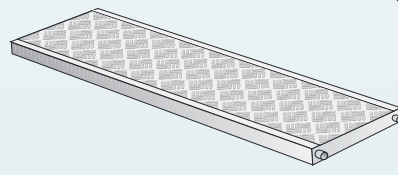

GHC 130

Griglia in ghisa
mm. 130x500

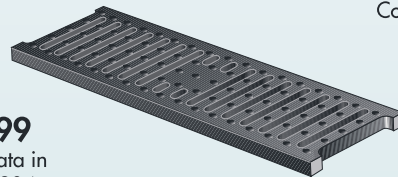

GSZ 13999

Griglia stampata zincata
mm. 130x1000

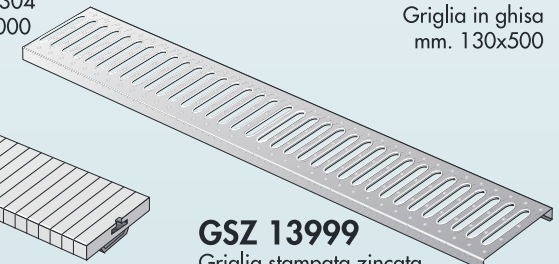

	mm.
A	137
B	130
C	20
D	115
H	150

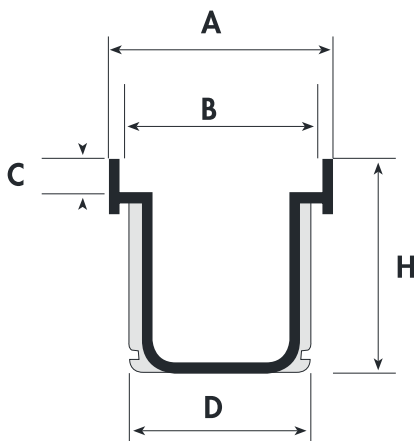

MODELLO	CARICO DI ROTTURA	DI L.F.	SEZIONE cm ² PASSAGGIO ACQUA	MATERIA PRIMA	COLORE
MG 13999	B	125	416	PA66FV	GRIGIO
MC 13999	B	125	--	PA66FV	GRIGIO
GRP 130	21 kN		70	PVC	GRIGIO-SABBIA-BIANCO
SGR 130	78 kN		294	PVC	GRIGIO-SABBIA
CGRN 130	115 kN		215	PVC	GRIGIO-SABBIA-ANTRACITE
TCRP 130	25 kN		--	PVC	GRIGIO-SABBIA
GHC 130	C	250	205	GHISA	NERO
GS 13999	15 kN		--	ACCIAIO	ACCIAIO
GSZ 13999	15 kN		235	ZINCATA	ZINCATO